

PRODUCT GUIDE

SEATING IN THE RIGHT PLACE



PHONE: 801-785-3363

www.seatinginnovations.com

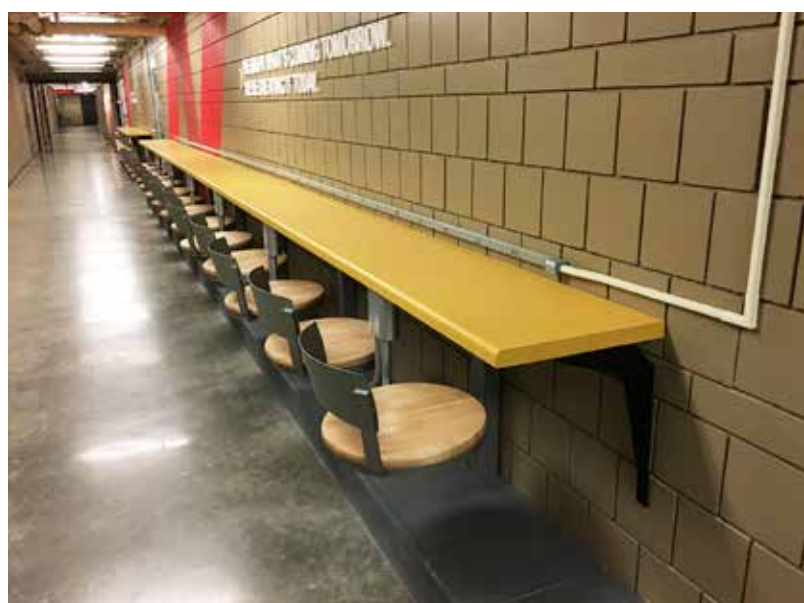

WELCOME TO THE WORLD OF SUSPENDED SEATING . . . A SIMPLE BUT REVOLUTIONARY IDEA

We love our products and are excited for you to explore the many ways you can use our suspended seating systems to add order and function to your home, office, restaurant, houseboat, school, library etc. The possibilities are endless...

As you browse through this product guide and our website, you will discover that we offer a variety of chair styles and options for both indoor and outdoor settings.

We would love to have the opportunity to work with you on your project. Please call us at 801-785-3363 with your questions.



CONTENTS

Where It All Began	4
Why Suspend	5
Photo Gallery	6 - 8
What You Should Know Before You Buy	9
Design Features	10
Steps to add Suspended Seating to your next Product	
Step 1 - Choose Your Layout	12
Step 2 - Choose Your Frame	13
Step 3 - Choose Your Hardware	14
Step 4 - Choose Your Chair	15 - 18
Step 5 - Choose Your Foot Rail	19
Step 6 - Place Your Order	20
Reviews	21

WHERE IT ALL BEGAN

HISTORY OF SEATING INNOVATIONS

CARLING & CARMA ALLEN

For over six decades people have been suspending their chairs, because it just makes sense.

In 1956, Carling Allen was asked by his wife Carma, “Can’t you do something to do away with the nuisance of chairs?” Chairs that mark and scratch the floor... chairs that are easily tipped over... chairs that are always cluttered and seldom left in place.

Faced with this unique request, Carling set out to design, patent and build the first 8 seat suspended table. The prototype featured only 4 legs instead of the common 36 legs to support the table and the chairs.

As word spread of the “Uni-dine Table,” a fledgling business was born to serve the local demand. As the years have passed, new features were added, upgraded and patented.

In 1995, Carling partnered with investors and formed the company Seating Innovations. Seating Innovation’s products have been enjoyed in a variety of residential and commercial settings, and are recommended by builders, re-modelers, cabinet dealers, interior designers, architects and homeowners everywhere.



WHY

SUSPEND CHAIRS

BECAUSE...

- You'll LOVE how easy it is to clean underneath the chairs
- You'll LOVE how the chairs always return to their resting position and look organized
- You'll LOVE that all sizes of family members and friends can enjoy using them
- You'll LOVE that there are no chair legs to scratch your floors

Suspended seating is one of the best investments you can add to your projects!

Watch this 1 minute [video to see how our chairs work](#)



Easy to clean



Chairs no longer tip over



Customizable



Chairs hold up to 500lbs



Chairs return



Prevents damage



Chairs can be installed in multiple locations

PHOTO GALLERY



Frame: High Bar
Finish: Satin Nickel
Chair: Contessa



Frame: Inverted
Finish: Satin Nickel
Chair: Mission

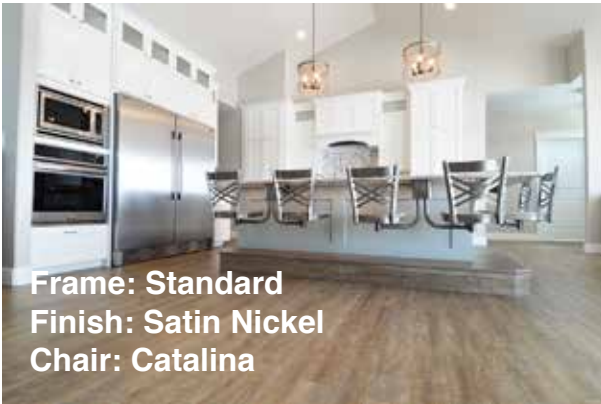

Frame: Standard
Finish: Satin Nickel
Chair: Catalina



Frame: Inverted
Finish: Black
Chair: Mission

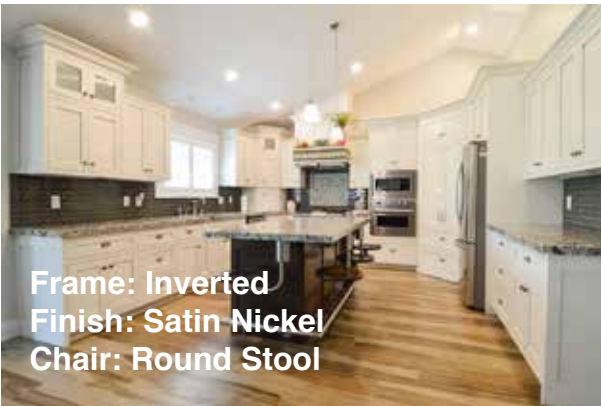

Frame: Inverted
Finish: Satin Nickel
Chair: Round Stool

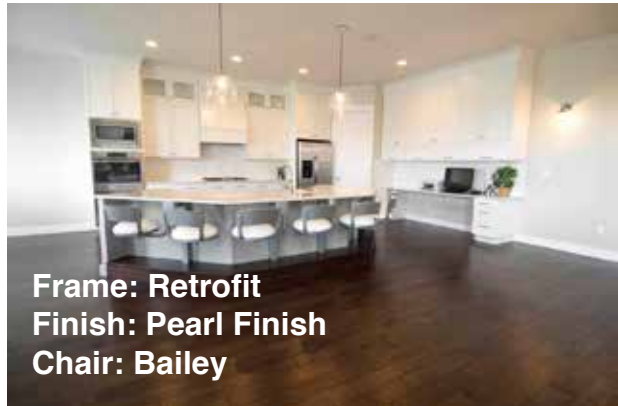

Frame: Retrofit
Finish: Pearl Finish
Chair: Bailey

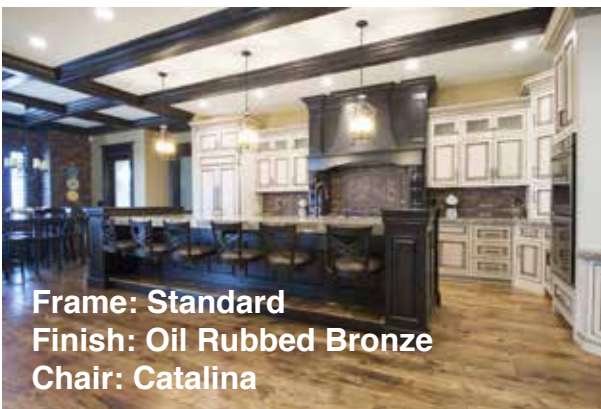

Frame: Standard
Finish: Oil Rubbed Bronze
Chair: Catalina



Frame: Standard
Finish: Black
Chair: Hayward

PHOTO GALLERY



Frame: Table
Finish: Satin Nickel
Chair: Bristol

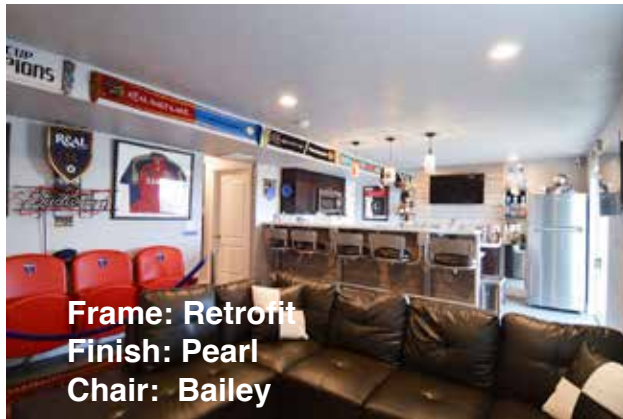

Frame: Retrofit
Finish: Pearl
Chair: Bailey

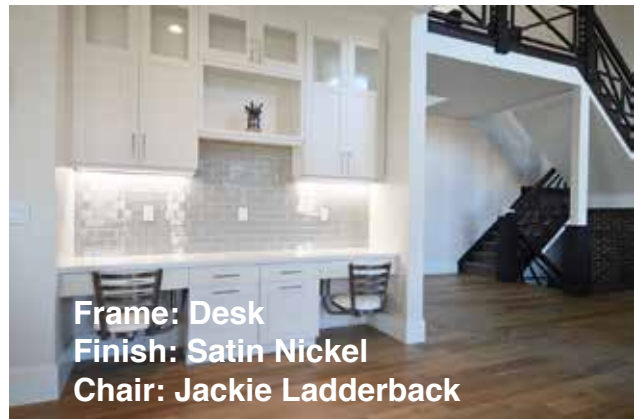

Frame: Desk
Finish: Satin Nickel
Chair: Jackie Ladderback



Frame: Inverted
Finish: Satin Nickel
Chair: Johnston Casuals 1529

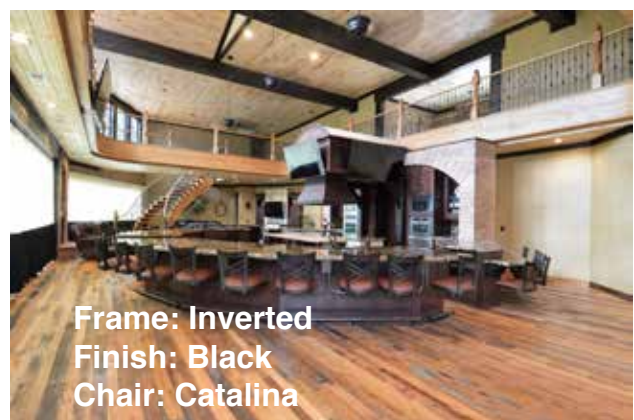

Frame: Inverted
Finish: Black
Chair: Catalina

PHOTO GALLERY

OUTDOOR APPLICATIONS

Seating Innovations is uniquely suited for outdoor kitchens and barbecues. We have a variety of chair styles and options that make the outdoor eating experience esthetically pleasing and very functional.

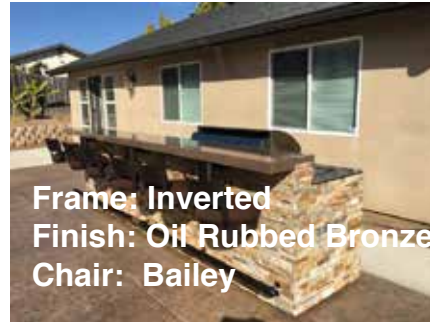

When our chairs are ordered for use in outdoor settings, we aren't able to guarantee against the chairs from rusting because of their exposure to the elements- rain, humidity etc. We do however, take extra precautions by applying a special coating to each individual exposed part of the suspended seating system and the chair.

We also recommend using the outdoor cushions on our chairs that we have built locally to our specifications. The cushions have marine quality plywood at the base, and plastic protective covering on the cushion itself prior to having the cushion upholstered using Sunbrella Outdoor fabric.

WHAT YOU SHOULD KNOW

BEFORE YOU BUY

Here are some frequently asked questions.

Does the countertop or cabinet need to be reinforced for suspended seating?

Seating Innovation's snack bars seats do not require modification to the cabinet or countertop. The suspended seating system is freestanding and mounts directly to the floor. The seating system's cantilever frame is typically concealed behind the finish panel and underneath the footrest, thus giving the illusion of chairs hanging from the countertop.

How many chairs can I fit on a kitchen island or snack bar?

Seating Innovations recommends spacing of 27 inches per chair. Most chair styles will require a minimum of 24 inches per chair. Some chairs have a wider seat and require customized systems that need more than 27 inches per chair. When the snack bar is next to a wall, Seating Innovations recommends 30 inches for the chair next to the wall to allow adequate access to the chair. Before finalizing your design, please check with us on the spacing necessary for your chair style selection.

Is the suspended seating system flush with the underside of the countertop?

On our inverted frames, the measurement from the floor mount to the underside of the countertop should correspond with our dimensions, however custom inverted frame sizes can be built as needed.

Standard frames can be raised (using the carriage bolts) so the top of the frame is flush with the top of the cabinet or underside of the countertop. There is a vertical adjustment of 3/4". This will ensure that the chairs will be the proper distance from the footrest and countertop for convenience and comfort. If the countertop is designed with a bull-nose feature, the suspended seating frame should be lowered enough to clear the drop of the bull-nose. Please use care to not drop the frame too far, thus compromising the positioning of the chair height.

What is the minimum countertop overhang for suspended seating?

The countertop overhang should be a minimum of 12 inches from the countertop edge to the finish panel on the cabinet. Seating Innovations recommends an overhang of 15 inches for the best comfort and ease of accessing the chairs. The suspended seating system can accommodate a maximum countertop overhang of 16 inches. *On our Retrofit frames the counter over hang needs to be 10"-12".

Is the installation a do-it-yourself project or is a professional installation required?

Installation is straight-forward with some basic understanding, tools and know how. Please refer to the Design/Installation Guide for specifics. A flooring contractor is typically used to cover a boxed in footrest. Please call us with any questions or design assistance.

DESIGN FEATURES

AND BENEFITS



Seating Innovation's patented designs and business operations lead the way in the suspended seating field including:

- 1** Superior Design - adjustable arm, seat stops, and torsion springs
- 2** Best Materials - heavy-duty steel construction with powder-coat finish on exposed parts
- 3** Highest Quality - manufactured and assembled in the USA
- 4** Easy Installation - multi-dimensional adjustment points to exactly fit your design
- 5** Optimum Performance - minimal maintenance
- 6** Responsive Customer Service - let us help you select the best seating system for your needs

STEPS TO ADD SUSPENDED SEATING

TO YOUR NEXT PROJECT

Step 1 - Choose Your Layout	11
Step 2 - Choose Your Frame	12
Step 3 - Choose Your Hardware	13
Step 4 - Choose Your Chair	14 - 17
Step 5 - Choose Your Foot Rail	18
Step 6 - Place Your Order	19



STEP 1

CHOOSE YOUR LAYOUT

We Offer Free Seating Design Layouts

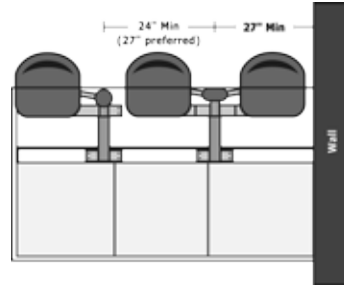
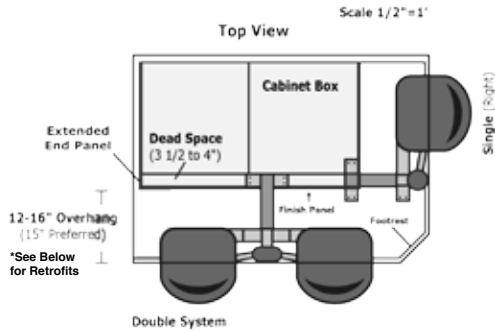

Standard Frames

Placed in dead space

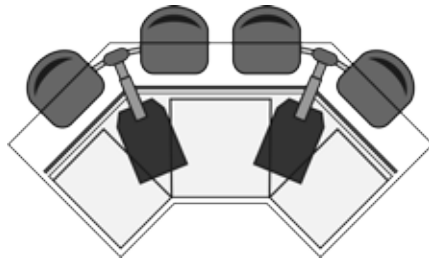

Inverted Frames

Placed in natural dead space between cabinet boxes

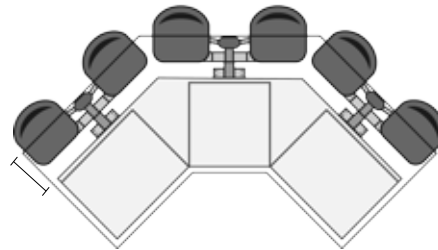

Retrofit Frames

Placed on the outside of the finish panel

DESIGN LAYOUT TIPS

The minimum spacing for our chairs is 24" per chair with 27" preferred. The minimum counter overhang for our standard and inverted frames is 12" with 15" preferred and 16" maximum. *On our Retrofit frames the counter overhang needs to be 10"-12".

FREE PROFESSIONAL LAYOUT DESIGN

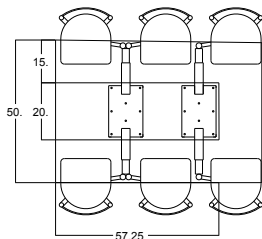

Let us help you determine the quantity and spacing of chairs

STEP 2

CHOOSE YOUR FRAME

STANDARD FRAME

The standard mounting requires 3 1/2 to 4" of dead space between the cabinet box and finish panel. The cantilever frames can also be placed in the dead space between angled cabinet boxes. Standard mounting requires a footrest to be built to cover the cantilever foot. Depending on the counter height, foot rail can be added above the footrest.

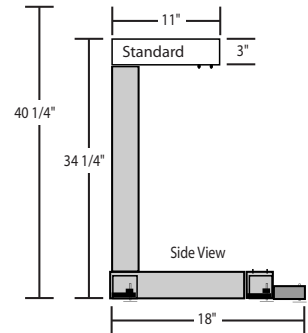
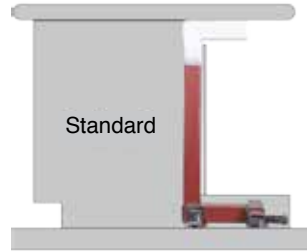

INVERTED FRAME

The inverted mounting requires 3 1/2 to 4" of dead space between the cabinet box and finish panel. The cantilever frames can also be placed in the dead space between angled cabinet boxes. Inverted mounting allows for foot rail to be mounted on the bottom of the cabinet's finish panel.

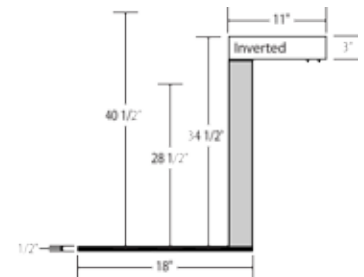
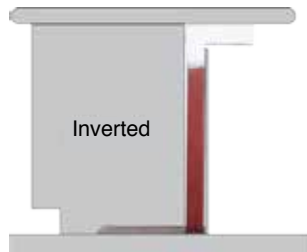

RETROFIT

Exposing the frame in front of the cabinet's finish panel works well on retrofit applications where existing cabinets are being used. Retrofit mounting requires a footrest to be built to cover the cantilever foot. Depending on the counter height, foot rail can be added above the footrest.

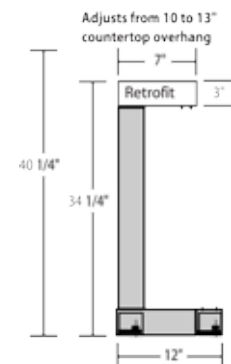

STEP 3

CHOOSE YOUR HARDWARE

ARM AND HEAD COVER COLOR FINISHES

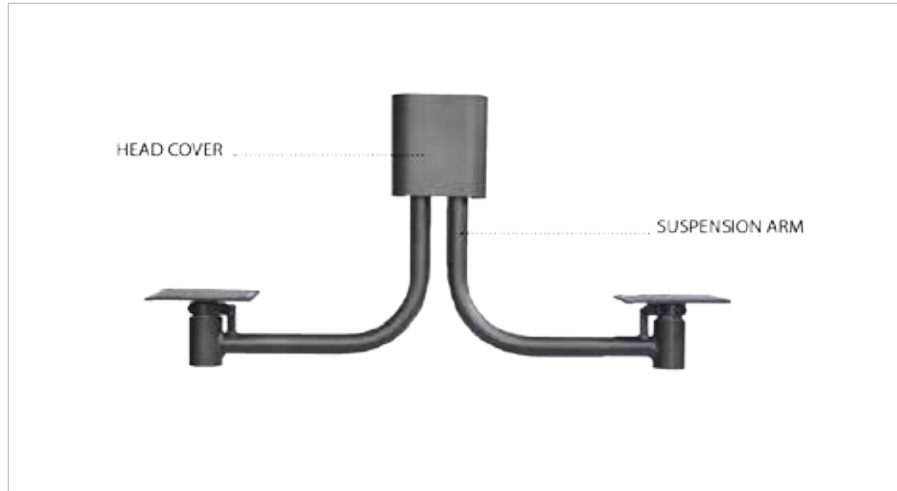

Seating Innovations offers a variety of finish colors for hardware. Standard finishes are included in the cost of the head assembly. For premium finishes, there is an additional upcharge per arm.

Standard Finish



Black

Other Finish



Satin Nickel

Premium Finishes

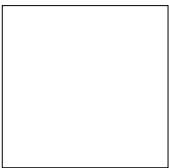

White



Silver Stardust



Pearl



Gun Metal

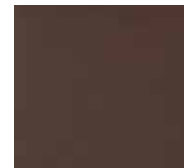

Rustic Brown



Oil Rubbed
Bronze

STEP 4

CHOOSE YOUR CHAIR

We offer chair styles from the following brands:
Holland, Callee, Stone County, and Johnston Casuals.



Catalina
Holland



Contessa
Holland



Jackie Ladderback
Holland



Lattice Back
Holland



Misha Wood
Holland



Solid Metal Back
Holland



Voltaire
Holland



Round Stool
Wood

STEP 4

CHOOSE YOUR CHAIR



Arcadia
Callee



Bailey
Callee



Bailey Backless
Callee



Bailey Padded
Callee



Baldwin
Callee



Berkley
Callee



Bristol
Callee



Charleston
Callee



Edison
Callee



Fairview
Callee



Hayward
Callee



Lonestar
Callee



Longhorn
Callee



Portville
Callee



Rochester
Callee



Sonoma
Callee



Valencia
Callee

STEP 4

CHOOSE YOUR CHAIR



Aspen
Stone County



Bull Moose
Stone County



Bistro
Stone County



Coffee Cup
Stone County



Forest Hill
Stone County



Green Forest
Stone County



Pine Cone
Stone County



Rushton Copper
Stone County



Tuscan
Stone County



Montage
Stone County



Parsley
Stone County



Pine
Stone County



Ranch
Stone County



Ranfurlie
Stone County



Rosemary
Stone County



Sage
Stone County



Sassfras
Stone County



Standard
Stone County



Thyme
Stone County



Waterbury
Stone County

STEP 4

CHOOSE YOUR CHAIR



Arena
Johnston Casuals



Cosmo
Johnston Casuals



Genesis Stool
Johnston Casuals



Helena
Johnston Casuals



JC7119
Johnston Casuals



Klingman
Johnston Casuals



Luca Stool Trellis
Johnston Casuals



Luca Stool Chianti
Johnston Casuals



Luca Stool Gothic
Johnston Casuals



Luca Stool Honey
Johnston Casuals



Luca Stool Juno
Johnston Casuals



Luca Stool Kuno
Johnston Casuals



Luca stool Nautilus
Johnston Casuals



Luca Stool Solo
Johnston Casuals



Luca Stool Eden
Johnston Casuals



Stiletto Barstool
Johnston Casuals



Summit
Johnston Casuals

STEP 5

CHOOSE YOUR FOOT RAIL

We recommend using our foot rail whenever our inverted frame is being used to provide a resting place for feet.



Standard Finishes



Satin Nickel



Brass

Premium Finishes

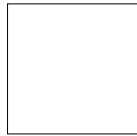

White



Silver
Stardust



Pearl

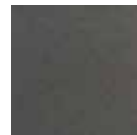

Gun Metal



Black



Rustic
Brown

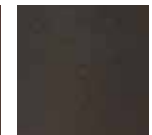

Oil Rubbed
Bronze

Foot Rail Brackets



402



404



600



602



730



830



530



732



A120

Selecting the right foot rail will give you the functionality and aesthetics that will enhance the style element in your home.

We offer the necessary components from brackets, tubing, end caps and angles. We can also customize the finish using the latest in powder-coating techniques. We would be happy to assist you in choosing the right foot rail options for your suspended seating.

STEP 6

PLACE YOUR ORDER

GIVE US A CALL

Let us help you in placing your order. 801-785-3363

support@seating-innovations.com

GET A QUOTE

Receive an estimated cost for the necessary parts needed to add suspended seating to your next project.

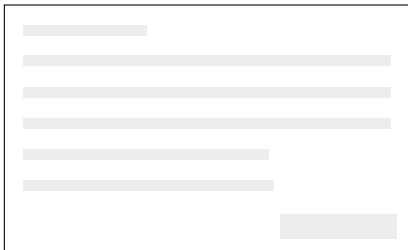

<https://seatinginnovations.com/quote>

FREE PROFESSIONAL LAYOUT DESIGN

Our professional design services are free with no obligation to buy seating. The digital layout will give you recommended spacing tailored to fit your project.

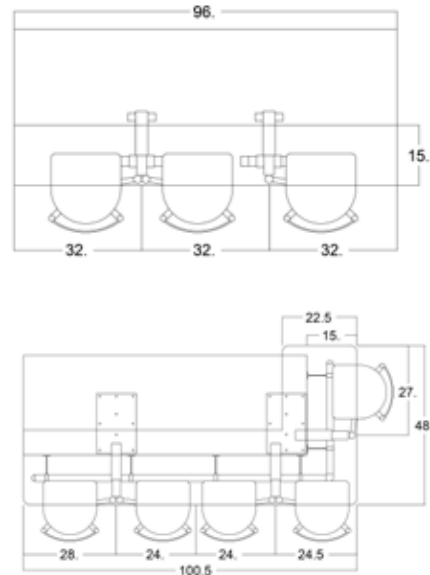

<https://seatinginnovations.com/seating-design>

SEATING INNOVATIONS LEAD TIME



FRAMES/POSTS

14-21 days out on building and shipping



HEAD ASSEMBLIES

8-12 weeks out on building and shipping



CHAIRS

8-12 weeks out depending on chair company

Thank you for taking the time to look at our products. We'd love to assist you with your next project. Please call us at 801-785-3363 to ask questions or to place your order.

REVIEWS

WHAT OUR CUSTOMERS ARE SAYING

“Thank you to Seating Innovations for updating my kitchen bar chairs. They actually installed plain white chairs over 17 years ago in this kitchen but it was time for a change! I love the new look! I love how the chairs are always in place. All those at Seating Innovations were great to work with. I totally recommend them for any projects you are considering!

B. Lovell
Homeowner

“This is the second time we have used this product. We had them in our last house for 18 years never had a problem. I installed them myself. The instructions were good and I never had a problem getting them to work. I have seen some cheaper ones, but they didn't look as nice.”

D. Wells
Homeowner

“I LOVE our new Seating Innovation barstools. I especially love the chic, contemporary look that these suspended stools add to my kitchen. My family had similar suspended barstools in our previous home, and knew that we could never go back to traditional barstools. I love that I never have to move the stools to sweep under them. And with 5 kids, I'm sure that traditional barstools would be all over the place, probably being dragged along (and scratching) our hardwood floor. I highly recommend these cool seats!”

C. Anderson
Homeowner

“We just did a new kitchen build-out and my sister recommended we check out Seating Innovations swivel chairs. Thank goodness she did---these are perfect, and the absolute HIGHLIGHT of our entire new kitchen! It's the first thing everyone notices, and everyone raves about them. Within our own family, I am so happy that my kids are no longer falling off stools, and clean-up is a breeze. I would not build another kitchen without these---and Seating Innovations was very helpful in the ordering process. I'm a fan!!

A. Lybb
Homeowner